

# B- Line

B-Line S.r.l.  
Via Galileo Galilei, 13/B  
35030 - Sarreola di Rubano (PD)  
ITALY

T. +39 049 8978245  
F. +39 049 633499  
E. [info@b-line.it](mailto:info@b-line.it)  
W. [b-line.it](http://b-line.it)

**ADAM**

Design by Buseti, Garuti, Redaelli

DATI TECNICI / TECHNICAL DATA

- IT** Tavolo da interno o esterno, disponibile in due altezze. Poggia sulla base, a singolo o doppio elemento, che prende forma attraverso la transizione da triangolo a cerchio. Il piano circolare o ellittico può essere in cristallo trasparente o retro-verniciato, quello circolare anche in laminato integrale; base in polietilene stampata in rotazionale.
- EN** An indoor or outdoor table, available in two heights. The top rests on a single or double base, which gets its shape from the transition from a triangle to a circle. The circular or elliptical top comes in back-painted or clear crystal glass; the circular top is also available in integrated laminate; rotomoulded polyethylene base.
- DE** Tisch für den Innen- oder Außenbereich. Erhältlich in zwei Höhen. Der Standfuß mit Einzel- oder Doppелеlement erhält seine Form durch die zunehmende Wandlung vom Dreieck zum Kreis. Die runde oder elliptische Tischplatte gibt es in den Ausführungen Transparentglas oder Kristallglas mit lackierter Rückseite, die runde Tischplatte auch in der Ausführung Kompaktlaminat. Standfuß aus im Rotomoulding-Verfahren geformtem Polyethylen.
- FR** Table d'intérieur ou d'extérieur, disponible en deux hauteurs. Elle repose sur sa base, à élément simple ou double, qui prend forme à travers la transition du triangle vers le cercle. Le plateau circulaire ou elliptique peut être en cristal transparent ou rétro-laqué. Le plateau circulaire peut aussi être en stratifié intégral ; piètement en polyéthylène moulé par rotomoulage.
- ES** Mesa para interiores o aire libre, disponible en dos alturas. Se apoya en la base, con elemento simple o doble, que toma forma a través de la transición de triángulo a círculo. El plano circular o elíptico puede ser de cristal transparente o retro-pintado; el plano circular también se ofrece de laminado integral; base de polietileno moldeado en rotacional.

H 1020 — Ø800

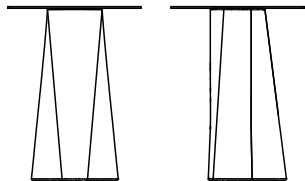

H 1020 — 2000x1000

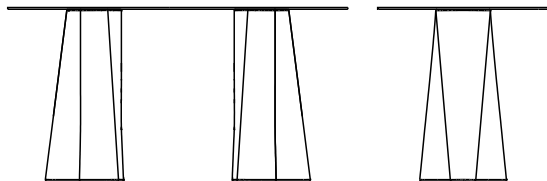

H 720 — Ø800

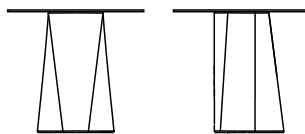

H 720 — Ø1000

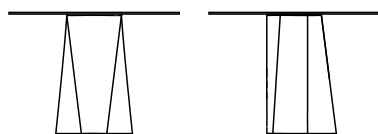

H 720 — 2000x1000

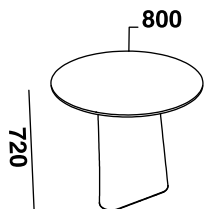
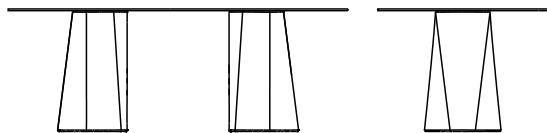

MOD. D01LB80 / D01LN80

<b>1</b>	<b>kg 14,40</b>	<b>kg 17,10</b>	<b>2</b>	<b>m<sup>3</sup> 0,21</b>	 <b>76,0</b> <b>8,5</b> <b>43,0 47,0 83,5 83,5</b>
Pezzi per collo Pièces per parcel Stückzahl pro Frachtstück Pièces par colis Piezas por bulto	Peso netto Net weight Nettogewicht Poids net Peso neto	Peso lordo Gross weight Bruttogewicht Poids brut Peso bruto	Numero colli Number of parcels Anzahl Frachtstücke Nombre de colis Número de bultos	Volume totale Total volume Gesamtvolumen Volume total Volumen total	Dimensioni Measures Abmessungen Dimensions Dimensiones

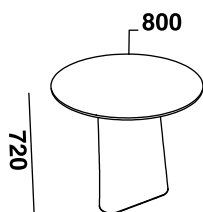

MOD. D01CT80

<b>1</b>	<b>kg 18,85</b>	<b>kg 25,50</b>	<b>2</b>	<b>m<sup>3</sup> 0,21</b>	
Pezzi per collo Pieces per parcel Stückzahl pro Frachtstück Pièces par colis Piezas por bulto	Peso netto Net weight Nettogewicht Poids net Peso neto	Peso lordo Gross weight Bruttogewicht Poids brut Peso bruto	Numero colli Number of parcels Anzahl Frachtstücke Nombre de colis Número de bultos	Volume totale Total volume Gesamtvolumen Volume total Volumen total	Dimensioni Measures Abmessungen Dimensions Dimensiones

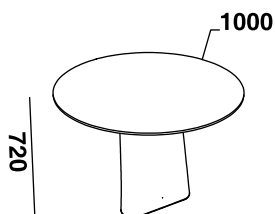

MOD. D01CT100 / D01CRB100

<b>1</b>	<b>kg 27,95</b>	<b>kg 37,50</b>	<b>2</b>	<b>m<sup>3</sup> 0,23</b>	
Pezzi per collo Pieces per parcel Stückzahl pro Frachtstück Pièces par colis Piezas por bulto	Peso netto Net weight Nettogewicht Poids net Peso neto	Peso lordo Gross weight Bruttogewicht Poids brut Peso bruto	Numero colli Number of parcels Anzahl Frachtstücke Nombre de colis Número de bultos	Volume totale Total volume Gesamtvolumen Volume total Volumen total	Dimensioni Measures Abmessungen Dimensions Dimensiones

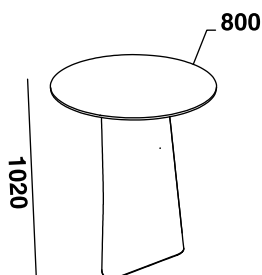

MOD. D02LB80 / D02LN80

<b>1</b>	<b>kg 17,40</b>	<b>kg 20,70</b>	<b>2</b>	<b>m<sup>3</sup> 0,34</b>	
Pezzi per collo Pieces per parcel Stückzahl pro Frachtstück Pièces par colis Piezas por bulto	Peso netto Net weight Nettogewicht Poids net Peso neto	Peso lordo Gross weight Bruttogewicht Poids brut Peso bruto	Numero colli Number of parcels Anzahl Frachtstücke Nombre de colis Número de bultos	Volume totale Total volume Gesamtvolumen Volume total Volumen total	Dimensioni Measures Abmessungen Dimensions Dimensiones

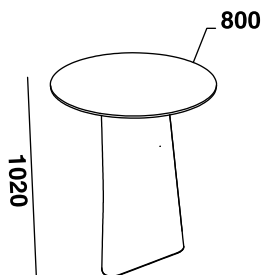

MOD. D02CT80

<b>1</b>	<b>kg 21,85</b>	<b>kg 29,20</b>	<b>2</b>	<b>m<sup>3</sup> 0,33</b>	<b>105,0</b> <b>49,0 54,0</b> <b>7,0</b> <b>86,0 86,0</b>
Pezzi per collo Pieces per parcel Stückzahl pro Frachtstück Pièces par colis Piezas por bulto	Peso netto Net weight Nettogewicht Poids net Peso neto	Peso lordo Gross weight Bruttogewicht Poids brut Peso bruto	Numero colli Number of parcels Anzahl Frachtstücke Nombre de colis Número de bultos	Volume totale Total volume Gesamtvolumen Volume total Volumen total	Dimensioni Measures Abmessungen Dimensions Dimensiones

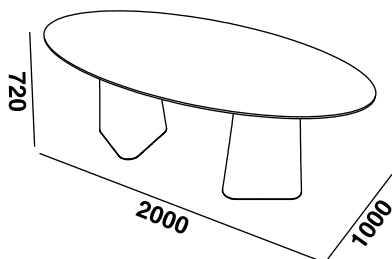

MOD. D03CT200 / D03CRB200

<b>1</b>	<b>kg 56,60</b>	<b>kg 70,20</b>	<b>3</b>	<b>m<sup>3</sup> 0,47</b>	<b>76,0</b> <b>43,0 47,0</b> <b>7,0</b> <b>76,0</b> <b>43,0 47,0</b> <b>110,0 210,0</b>
Pezzi per collo Pieces per parcel Stückzahl pro Frachtstück Pièces par colis Piezas por bulto	Peso netto Net weight Nettogewicht Poids net Peso neto	Peso lordo Gross weight Bruttogewicht Poids brut Peso bruto	Numero colli Number of parcels Anzahl Frachtstücke Nombre de colis Número de bultos	Volume totale Total volume Gesamtvolumen Volume total Volumen total	Dimensioni Measures Abmessungen Dimensions Dimensiones

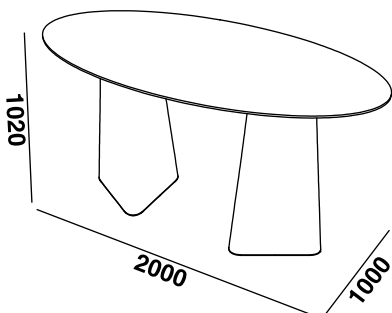

MOD. D04CT200 / D04CRB200

<b>1</b>	<b>kg 62,80</b>	<b>kg 77,50</b>	<b>3</b>	<b>m<sup>3</sup> 0,73</b>	<b>105,0</b> <b>49,0 54,0</b> <b>7,0</b> <b>105,0</b> <b>49,0 54,0</b> <b>110,0 210,0</b>
Pezzi per collo Pieces per parcel Stückzahl pro Frachtstück Pièces par colis Piezas por bulto	Peso netto Net weight Nettogewicht Poids net Peso neto	Peso lordo Gross weight Bruttogewicht Poids brut Peso bruto	Numero colli Number of parcels Anzahl Frachtstücke Nombre de colis Número de bultos	Volume totale Total volume Gesamtvolumen Volume total Volumen total	Dimensioni Measures Abmessungen Dimensions Dimensiones

Piani / Tops / Tischplatten / Plateaux / Planos

-  **LB80 - Ø80**  
Laminato Bianco / White Laminate / Weißes Laminat / Stratifié Blanc / Laminado Blanco
-  **LN80 - Ø80**  
Laminato Nero / Black Laminate / Schwarzes Laminat / Stratifié Noir / Laminado Negro
-  **CT80 - Ø80 / CT100 - Ø100**  
Cristallo Trasparente / Clear Crystal Glass / Transparentes Kristallglas / Cristal Transparent / Cristal Transparente
-  **CRB100 - Ø100**  
Cristallo Bianco / White Crystal Glass / Weißes Kristallglas / Cristal Blanc / Cristal Blanco
-  **CT200 - 100 x 200**  
Cristallo Trasparente / Clear Crystal Glass / Transparentes Kristallglas / Cristal Transparent / Cristal Transparente
-  **CRB200 - 100 x 200**  
Cristallo Bianco / White Crystal Glass / Weißes Kristallglas / Cristal Blanc / Cristal Blanco

Inserto Piastra di supporto / Insert Support plate / Einsatz Stützplatte / Insert Plaque de support / Perno Placa de soporte  
Acciaio / Steel / Stahl / Acier / Acero

Basamenti / Bases / Standfüße / Piètements / Bases

Polietilene (PE) stampato in rotazionale / Rotomoulded polyethylene (PE) / Polyethylen (PE), hergestellt im Rotomoulding-Verfahren / Polyéthylène (PE) moulé par rotomoulage / Polietileno (PE) moldeado en rotomoulding

Finitura / Finish / Ausführung / Finition / Acabado







-  **Bianco / White / Weiß / Blanc / Blanco EASY CLEAN**
-  **Rosso Corallo / Coral Red / Korallenrot / Rouge Corail / Rojo Coral**
-  **Grigio Basalto / Basalt Grey / Basaltgrau / Gris Basalte / Gris Basalto**
-  **Pine**
-  **Utilizzabile all'esterno / Can be used outdoors / Im Außenbereich verwendbar / Peut être utilisé à l'extérieur / Utilizable al aire libre**
-  **Utilizzabile sotto la pioggia / Can be used in the rain / Bei Regen verwendbar / Peut être utilisé sous la pluie / Utilizable bajo la lluvia**

TABELLA CARICHI / LOADS TABLE / LASTENTABELLE / TABLEAU DES CHARGES / TABLA DE LAS CARGAS

MOD.	PIANI / TOPS / PLATTEN / PLATEAUX / PLANOS	ZAVORRA / BALLAST / BALLAST / LEST / LASTRE
D01 Ø 80	Laminato / Laminate / Laminat / Stratifié / Laminado	Kg. 16
D01 Ø 80	Cristallo / Crystal glass / Kristallglas / Cristal / Cristal	Kg. 12
D01 Ø 100	Cristallo / Crystal glass / Kristallglas / Cristal / Cristal	Kg. 24
D02 Ø 80	Laminato / Laminate / Laminat / Stratifié / Laminado	Kg. 10
D02 Ø 80	Cristallo / Crystal glass / Kristallglas / Cristal / Cristal	Kg. 6
D03 100x200	Cristallo / Crystal glass / Kristallglas / Cristal / Cristal	Kg. 0
D04 100x200	Cristallo / Crystal glass / Kristallglas / Cristal / Cristal	Kg. 0